

ORIGINAL SPECIFICATION JAGUAR INTERIORS

WOOD COMPONENTS FOR SEAT FRAMES* XK120 SERIES & XK140 SERIES

XK120 SERIES

ROADSTER-ARCH BACK

DESCRIPTION	ILLUS. NO.
Kit No: 0193ARW	
Plywood Seat Back	1
Hardwood Tack Strip	2
Plywood Tack Strip, seat	3
Plywood Tack Strip, seat	4
Hardwood Tack Strip	5
Plywood Cushion Frame	6
Hardwood Seat Back	7
Plywood Side Panel	9
Hardwood Top Strip	11

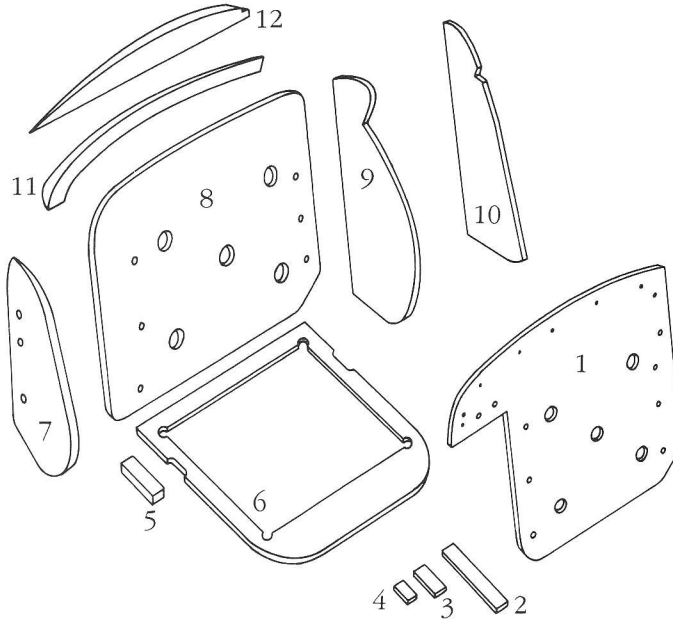

ROADSTER-STRAIGHT BACK

DESCRIPTION	ILLUS. NO.
Kit No: 0193BRW	
Plywood Seat Back	1
Hardwood Tack Strip	2
Plywood Tack Strip, seat	3
Plywood Tack Strip, seat	4
Hardwood Tack Strip	5
Plywood Cushion Frame	6
Hardwood Seat Back	7
Plywood Side Panel	10
Hardwood Top Strip	12

DHC/FHC-ARCH BACK

DESCRIPTION	ILLUS. NO.
Kit No: 0193ADFW	
Plywood Seat Back	8
Hardwood Tack Strip	5
Plywood Cushion Frame	6
Hardwood Seat Back	7
Plywood Side Panel	9
Hardwood Top Strip	11

DHC/FHC-STRAIGHT BACK

DESCRIPTION	ILLUS. NO.
Kit No: 0193BDFW	
Plywood Seat Back	8
Hardwood Tack Strip	5
Plywood Cushion Frame	6
Hardwood Seat Back	7
Plywood Side Panel	10
Hardwood Top Strip	12

XK140 SERIES

ROADSTER

DESCRIPTION	ILLUS. NO.
Kit No: 0203RW	
Plywood Seat Back	1
Hardwood Top Strip	2
Hardwood Side Panel	3
Hardwood Block	4
Plywood Side Panel	5
Plywood Tack Strip	6
Small Plywood Strip	7
Plywood Brace	8
Plywood Seat Base	9

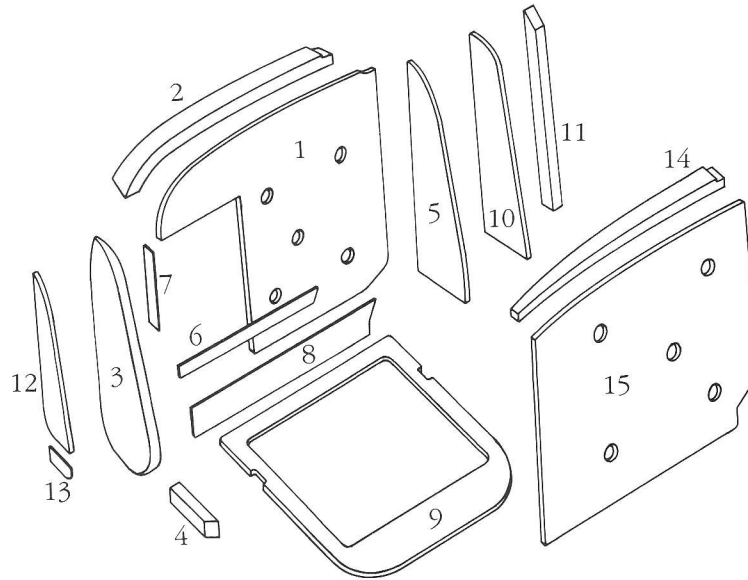

DHC/FHC

DESCRIPTION	ILLUS. NO.
Kit No: 0203DFW	
Plywood Seat Back	15
Hardwood Top Strip	14
Hardwood Side Panel	12
Small Plywood Tack Strip	13
Plywood Side Panel	10
Hardwood Side Panel Brace	11
Plywood Seat Base	9