

# ORIGINAL SPECIFICATION JAGUAR INTERIORS

## RUBBER SEALS

*XK140 ROADSTER, DHC & FHC, 1955-1957*

PART NO.	DESCRIPTION	PART NO.	DESCRIPTION	ILLUS. NO.	PART NO.	DESCRIPTION	ILLUS. NO.	PART NO.	DESCRIPTION	ILLUS. NO.
<b>MAJOR KITS</b>		<b>XK140 SERIES • ALL</b>			<b>ROADSTER</b>			<b>FIXEDHEAD COUPE</b>		
140R1	ROADSTER, all	C9926	Indicator Pad	8	BD2045/8	A-Post/Sill Seal	19	BD7960	Windscreen Seal	24A/B
140D2	DROPHEAD COUPE, all	C2659*	Dip Switch Boot	10	BD2159	Windscreen to Cowl	20	BD10303	Inner Window Wipe	25
140F3	FIXEDHEAD COUPE, all	3461	Headlamp Seal	9	BD3887	Windscreen Post Pad	21	BD11030/1	¼ Light Stand Pillar	31
		6671	Taillight Pad	3	BD4374	Top to Windscreen	22	BD10003	Inner ¼ Light Seal	32
		5315	Taillight Lens Seal	4	<b>DROPHEAD COUPE</b>			BD2012/6	Outer ¼ Light Seal	33
		BD4616	Bonnet Buffer	11	BD4814/3	A-Post & Top to Windscreen	23	BD2012/5	Cantrail Seal	34
		792*	Clutch & Brake Pedal Pad, ea.	12	BD7960	Windscreen Seal	24A/B	BD2159/6	B-Post Seal	28
		C3473*	Accelerator Pad	13	BD6027	Outer Window Wipe		BD2045/8	A-Post Seal	19
		BD5190	Wing Vent Seal	14	BD4814/4	Cantrail Seal	26	BD2045/10	Sill Seal	35
		BD4354	Fuel Lid Seal	7	BD4814/5	Upper Head Pillar	27	BD9759	Rear Window Seal	36
		C5497	Window Washer Jet Pad	15	BD2159/6	B-Post Seal	28	BD10613/1	Door Handle Pads, set of two per door, car set	29
		C5522/2	Wiper Bezel Pad	16	BD2045/8	Sill Seal	19			
		BD10331	Inner Rear Bumper Grommet	1	BD8065/1	Door Handle Pad, one per door, ea.	30			
		BD10330	Outer Rear Bumper Grommet	2						
		C8093*	Steering Column Grommet	17						
		C8166*	Brake & Clutch Dust Exc., ea.	18						
		BD9868	Override Seal, ea.	5						
		BD9345/2	Boot Lid Seal	6						
		BD9345/3	Lower Boot Lid Seal	6						

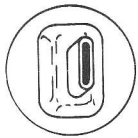

1



2

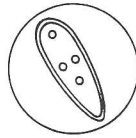

3



4

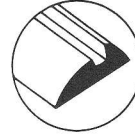

5<sup>1</sup>

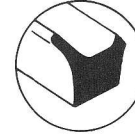

6

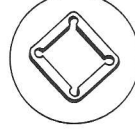

7

<sup>1</sup>5 Eight locations, front and rear

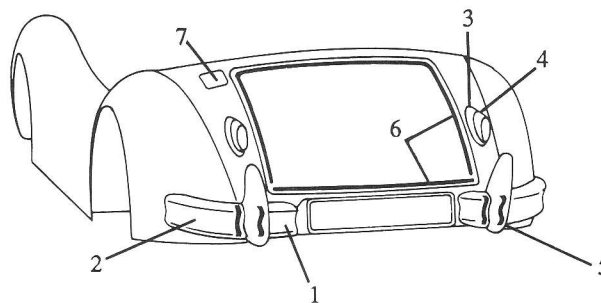

\*not included in major seal kits

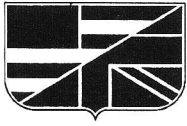

# ORIGINAL SPECIFICATION JAGUAR INTERIORS

## RUBBER SEALS

XK140 ROADSTER, DHC & FHC, 1955-1957

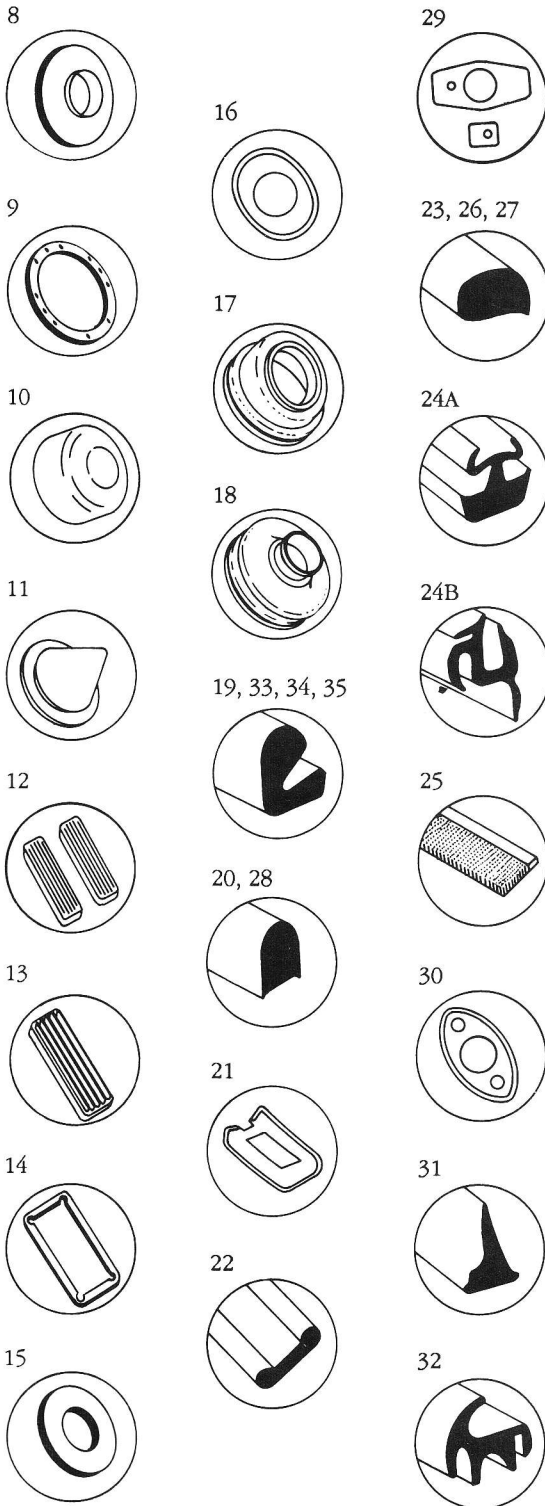

<sup>15</sup> Eight locations, front and rear

